

Gendarmerie St. Tropez

H0 9276

Hinweise für den Zusammenbau:

Der Bausatz besteht aus durchgefärbtem Architektur-Hartkarton in matter, realistischer Farbgebung und benötigt daher keine Lackierung, kann jedoch z.B. mit Pulverfarben oder vielen anderen Farben lackiert oder gealtert werden.

Die Anhängpunkte der Bauteile sind z.B. mit einem Cutter zu lösen.

Für die Verklebung wird handelsüblicher Express-Holzleim empfohlen. Der Kleber sollte dünn und flächig verteilt werden. Bei kleinen Bauteilen kann der Kleber z.B. mit einem Zahnstocher aufgetragen werden. Für die Verklebung der Fensterfolie wird Alleskleber empfohlen.

Die Bauteile sollten nach dem Verkleben einige Minuten mit Gewichten beschwert oder mit Klammern zusammengepresst werden.

Recommendations:

Please cut the marking points of the parts with a sharp cutter. It is recommended to use wood glue. Please use the glue only thin and on the complete surface of the parts, use e.g. a small wooden pick. For the windows general-purpose glue should be used.

After glueing the parts should be pressed with heavy weights or clips.

Inhalt:

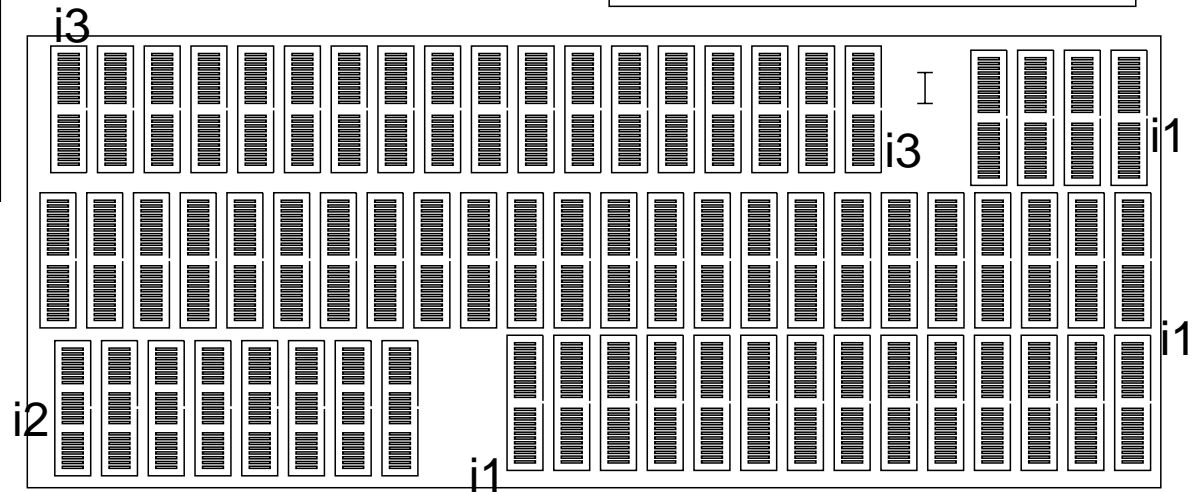
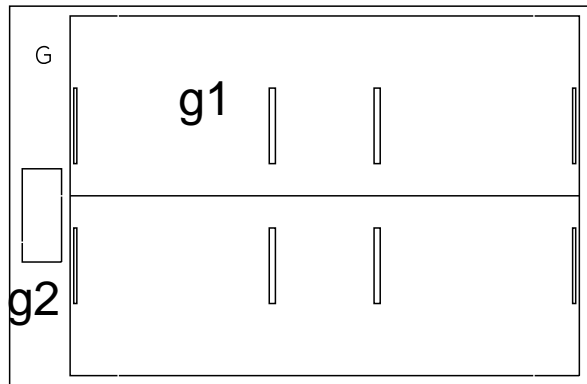
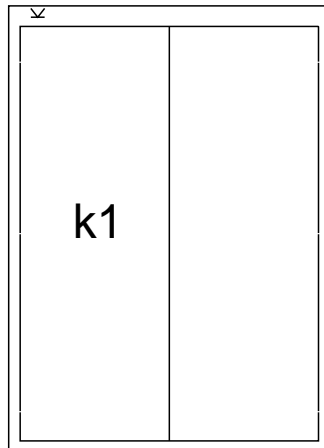
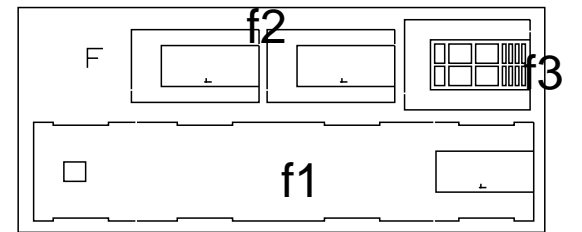
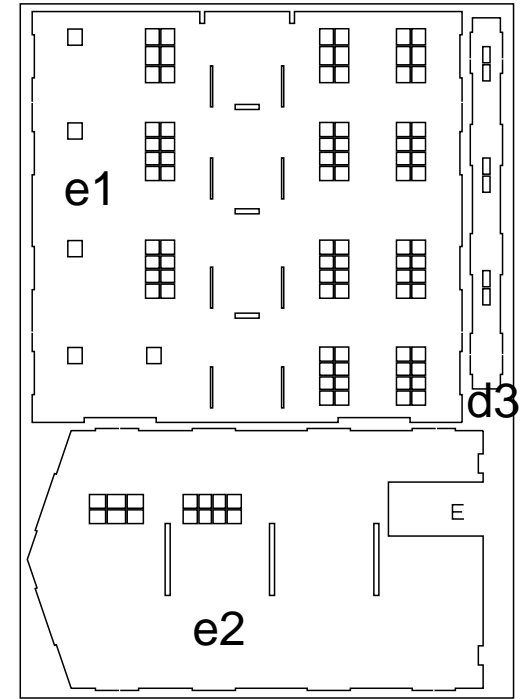
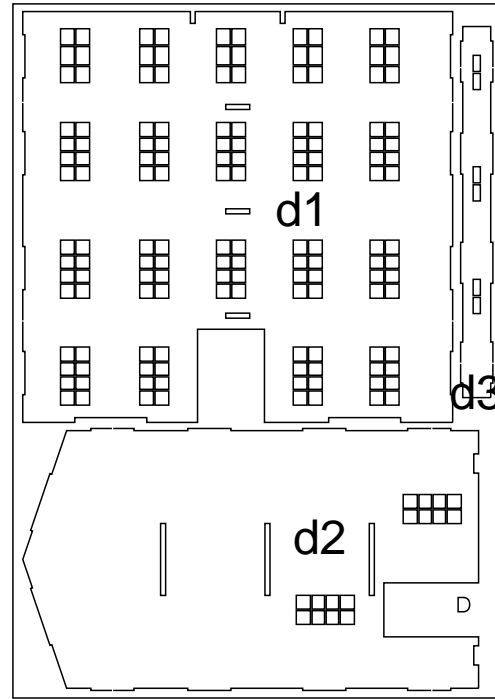
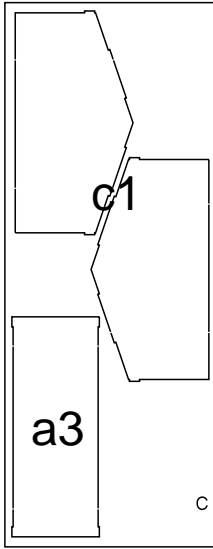
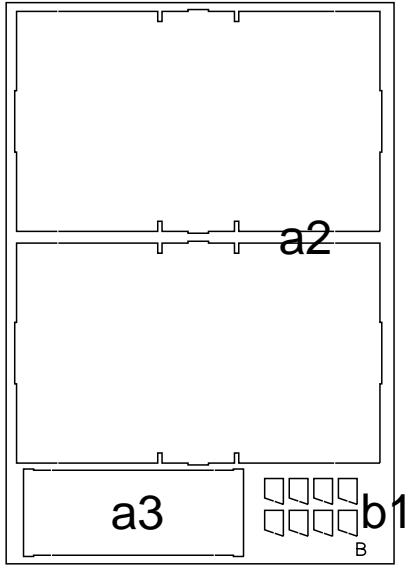
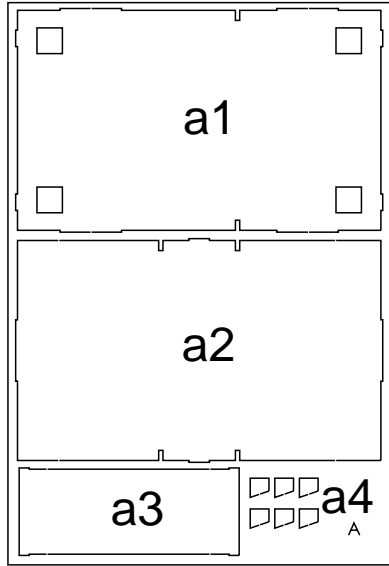

GENDARMERIE NATIONALE

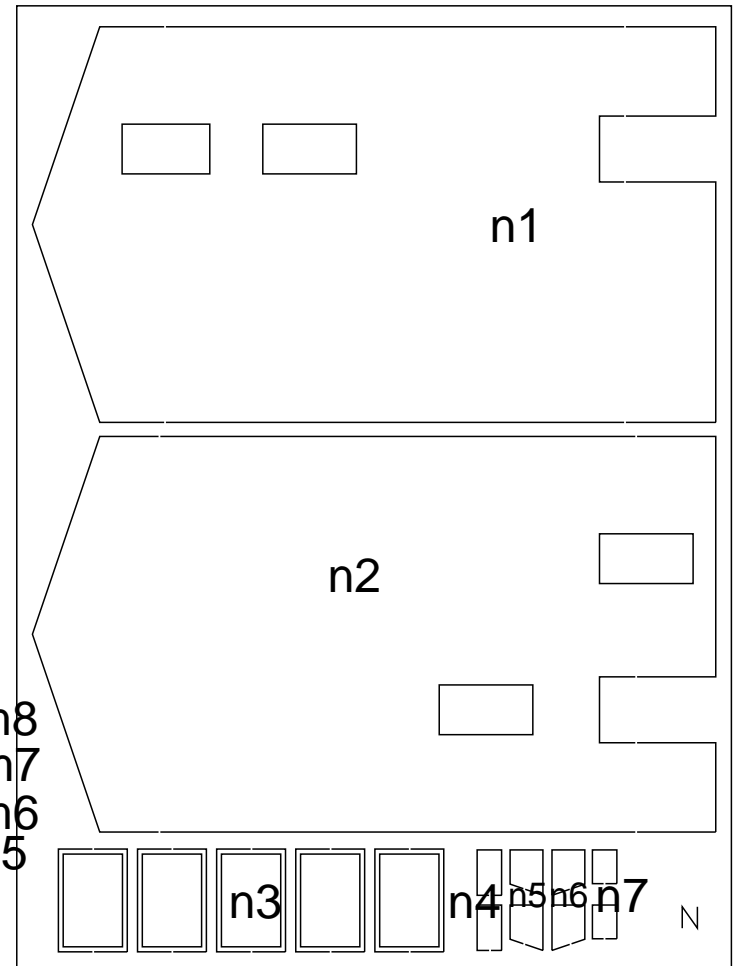
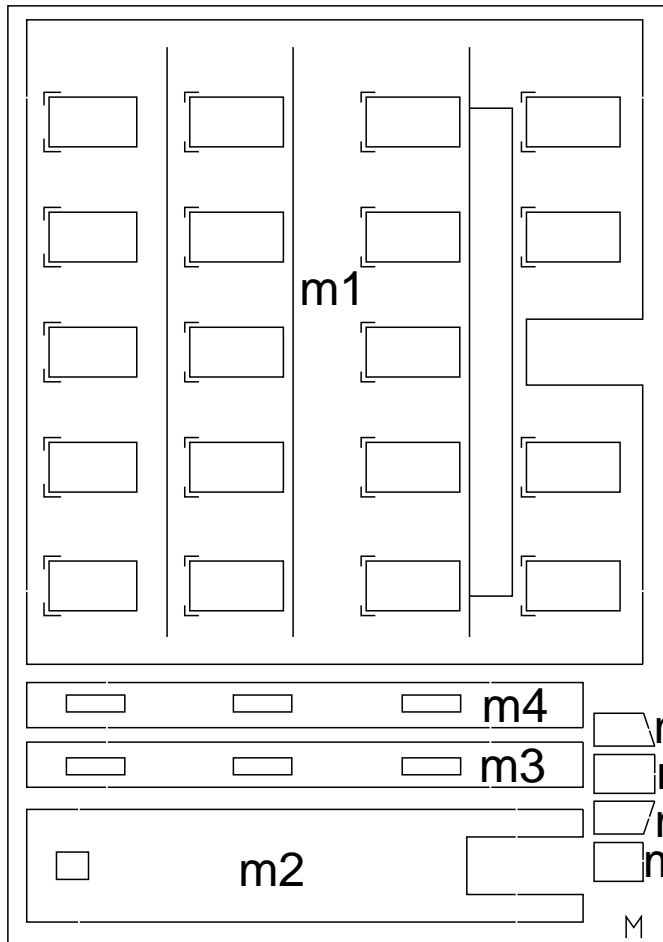
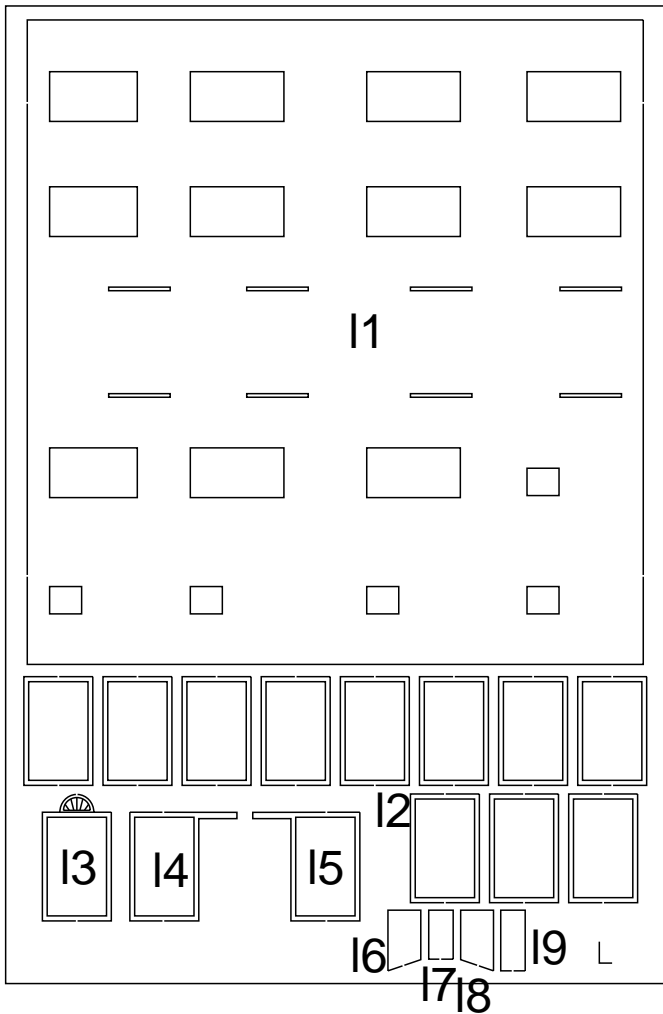
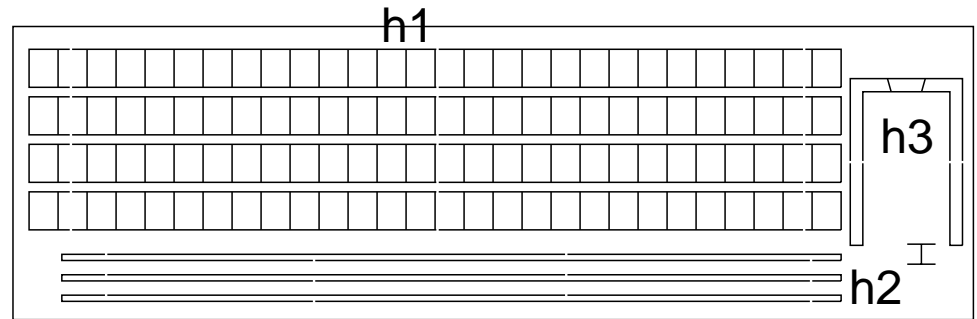
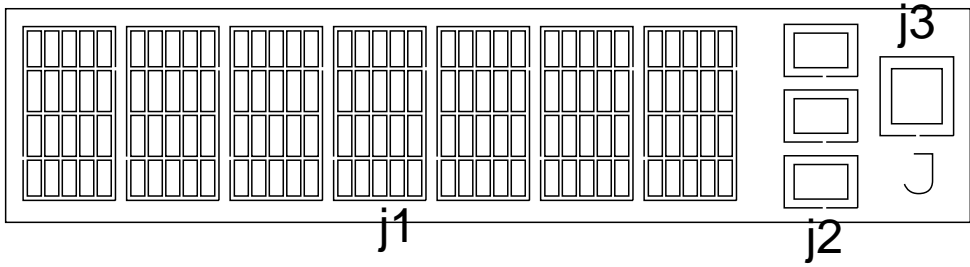

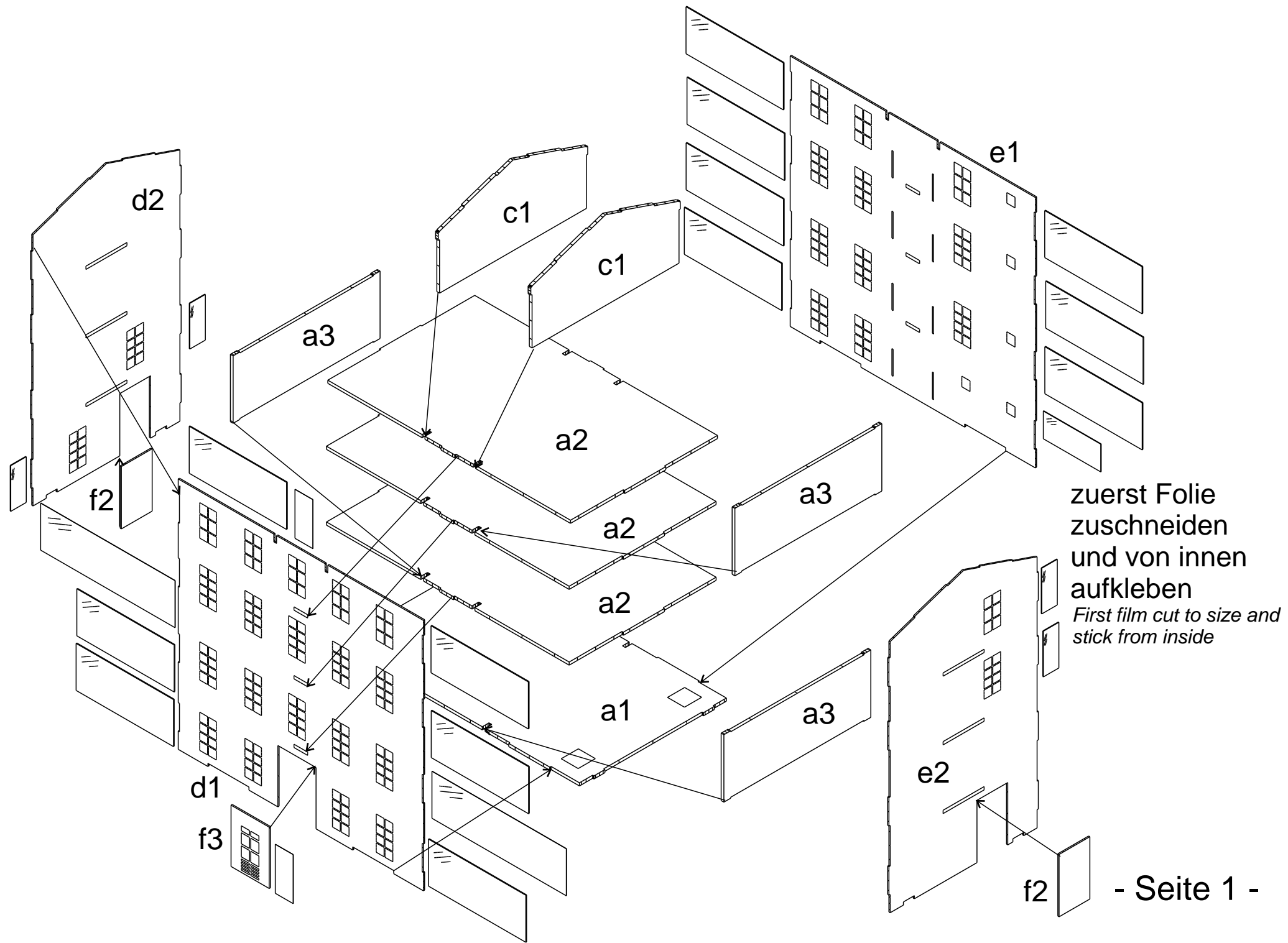

zuerst Folie
 zuschneiden
 und von innen
 aufkleben
*First film cut to size and
 stick from inside*

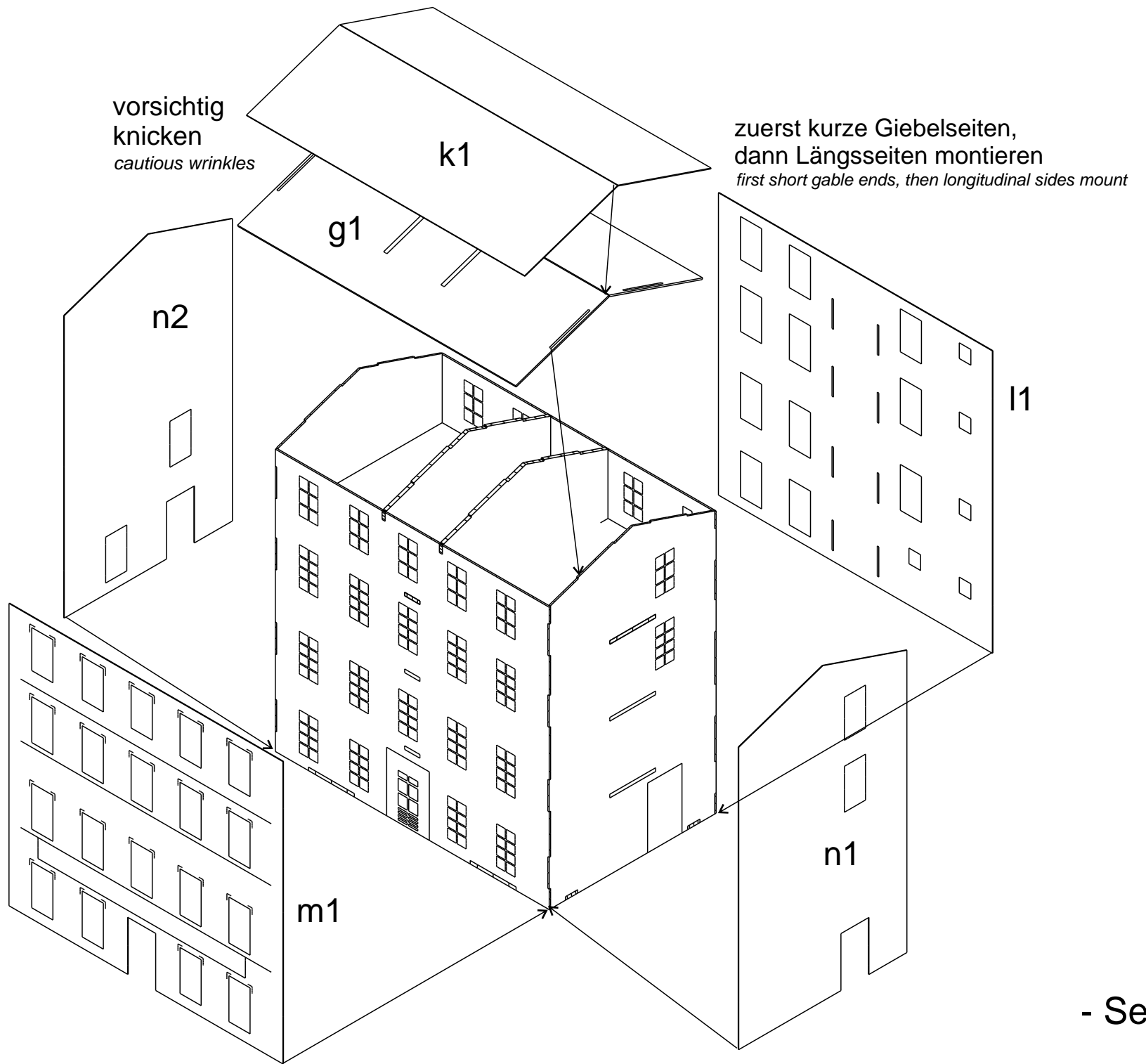

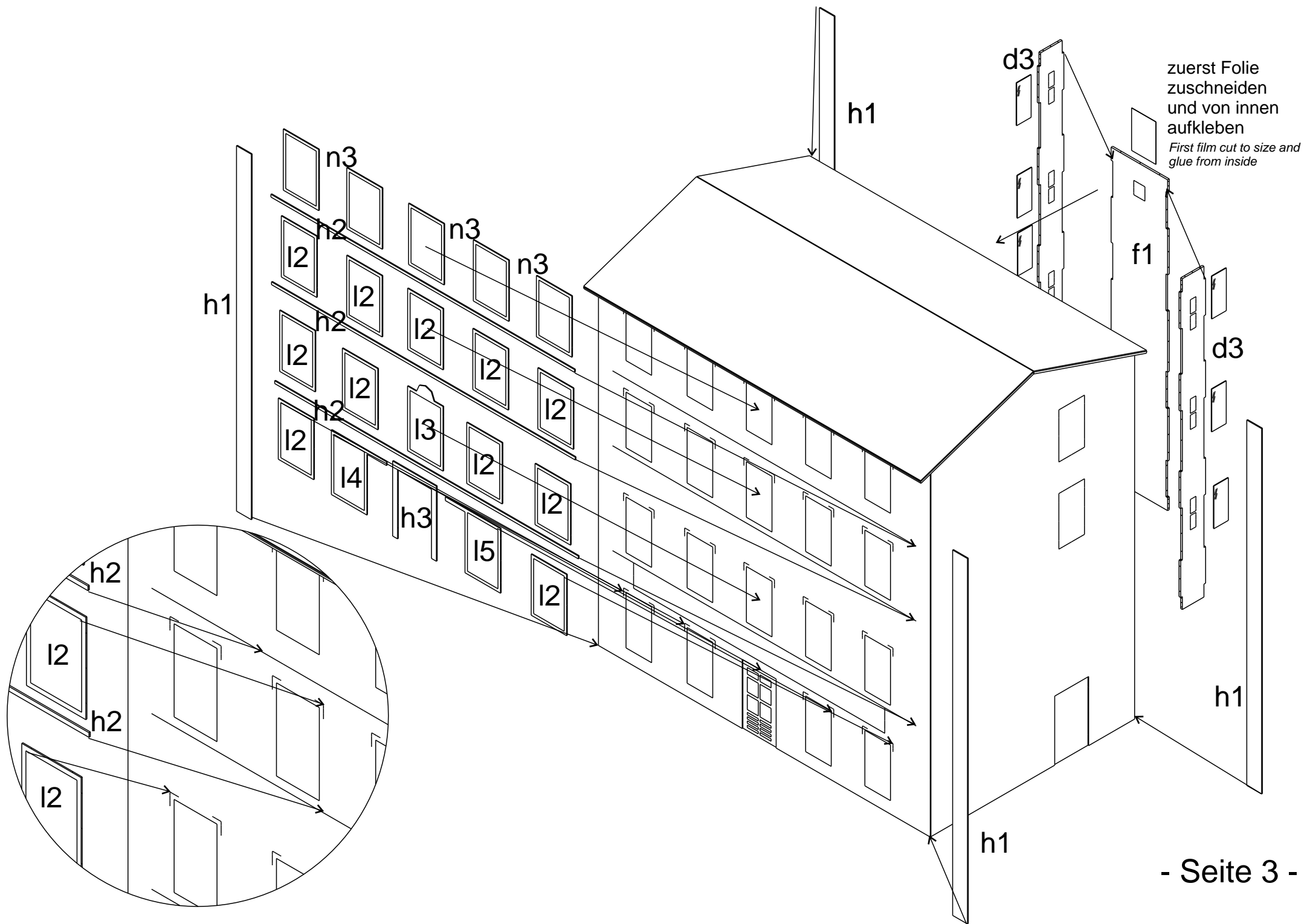

2x montieren

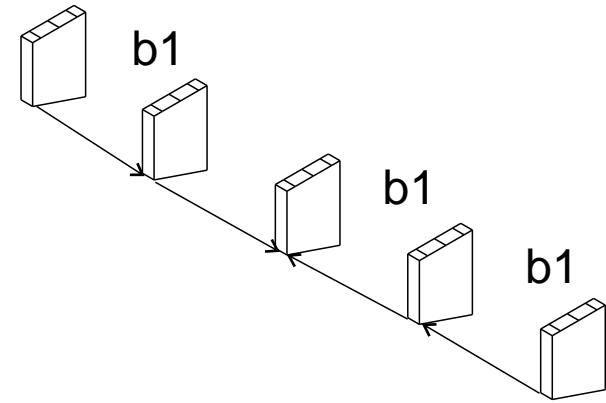
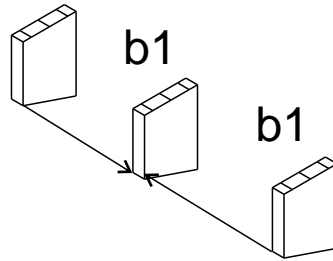
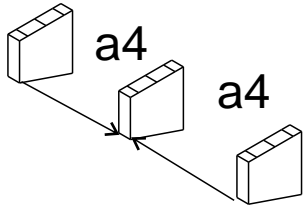

2x montieren

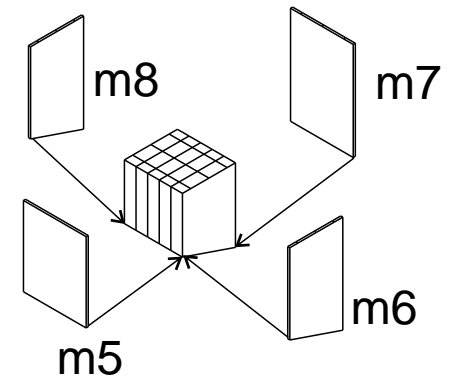
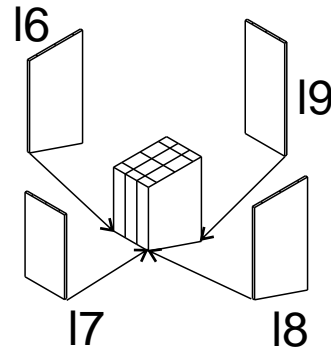
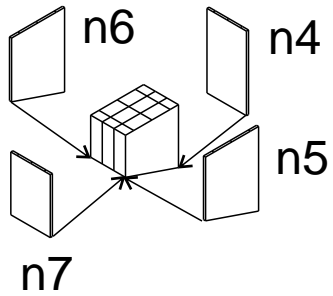

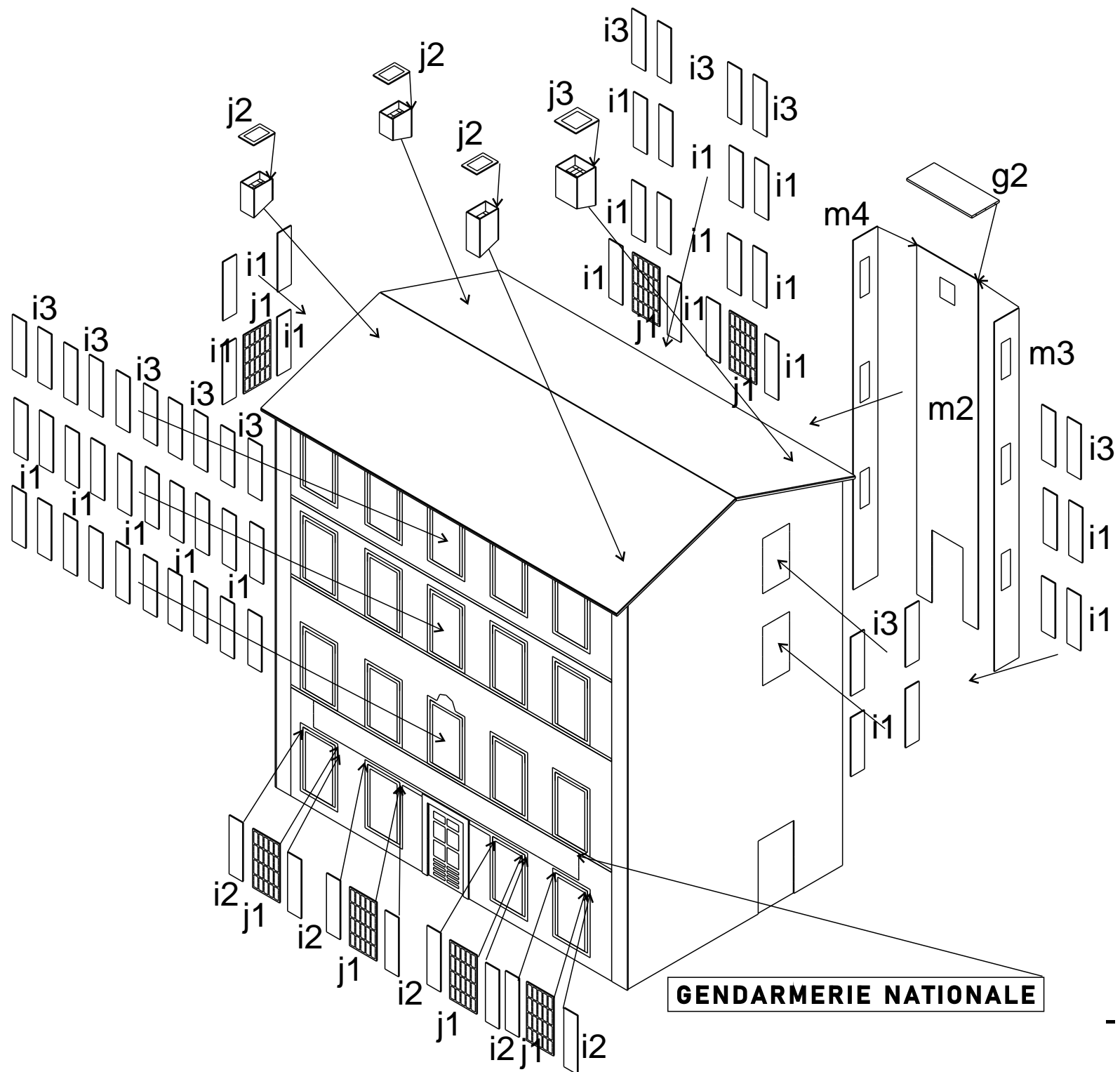

GENDARMERIE NATIONALE

Made by



14+ 